

Multi-Touch Interactive Whiteboard

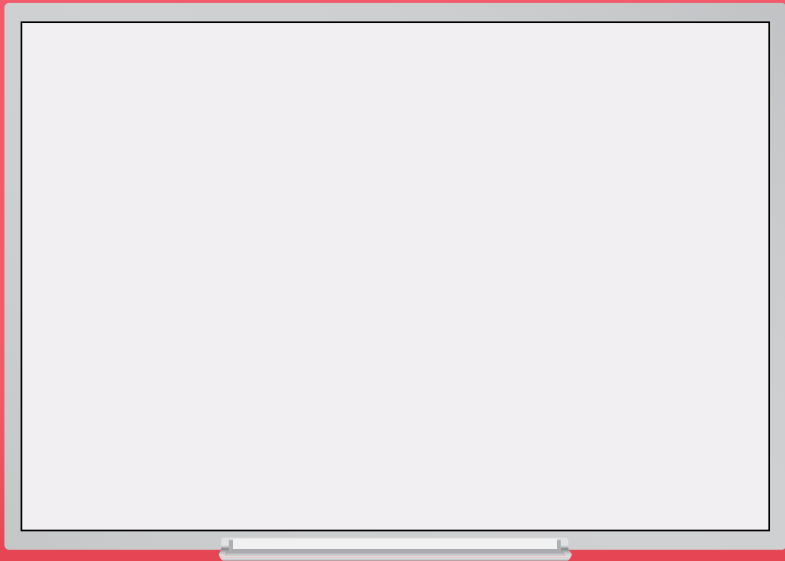

User Manual V7.0
(Windows Version)

Note

For your own safety, please read this User Manual carefully before use. Follow all the installation instructions carefully and keep this User Manual properly for future reference.



Safety Information

Meaning of Signal Words



WARNING

Indicates a potential hazard that could result in serious injury or death and/or property damage.



CAUTION

Indicates hazards that could result in minor or moderate injury and/or property damage.

1. Safety Information (Continue....)



WARNING

- Follow all the installation instructions carefully.
- This product is designed and intended for indoor use only.
- Do not expose this product to water or moisture in order to avoid fire and electric shock. Do not operate this product in a damp environment.
- Always place this product on stable and level surface.
- Use only the designated wall mount or mobile stand hardware.
- Always use this product at the indicated supply voltage only. Failure to do so may result in fire, electric shock, or product damage.
- Use only the included power cord, power plug or power adaptor. Use of other types of power cord, power plug, or adaptor may result in fire or electric shock.
- Always insert the power plug or power adaptor fully into the power outlet. Otherwise, it may result in overheat, electric shock or fire.
- If the power plug does not fit into the power outlet, contact a licensed electrician to replace the obsolete outlet.
- When unplugging the power plug or power adaptor, hold it by the plug. Do not pull on the power cord as it may damage to the power cord and may cause fire or electric shock.
- Do not bend or twist, or place any heavy object on the power cord.

Safety Information



WARNING

1. Safety Information (Continue....)

- Protect the power cord from being walked on or pinched particularly at plugs, convenience receptacles, and the point where they exit from the apparatus.
- Do not open or alter the casing of this product. Electric shock or injury may result.
- Do not attempt to repair, modify, or disassemble this product. If any part of this product is damaged or frayed, contact an authorized service representative.
- Never handle this product with wet hands as it may result in electric shock.
- If the product emits smoke, excessive heat, abnormal smell or unusual noise, turn off the product and unplug the power plug immediately. Contact an authorized service representative.
- Do not insert any metallic objects into this product or into a contact.
- Unplug the power plug or power adaptor before cleaning. Always use a dry, soft cloth for cleaning.
- Carefully locate any parts and/or accessories of this product to avoid potential tripping hazards.
- Do not operate this product at high temperature and/or high humidity environment. Application ambient conditions: Temperature: 10°C to 40°C; Humidity: 10% to 80%; Non-condensing.
- This product must be disposed in accordance with the relevant federal, state, and local laws and regulations.
- Never allow children to operate this product without proper adult supervision.
- Do not install this product except by qualified service personnel.
- Do not place this product near any heat sources above 100°C.

Safety Information



CAUTION

1. Safety Information (Continue....)

- Do not expose this product to excessive dust or vibrations, or high humidity, extreme cold or heat (such as in direct sunlight, near a heater, or near an air-conditioning vent).
- Do not install this product where it would be exposed to direct sunlight or strong lighting.
- Do not place a heavy object on this product to avoid product damage.
- Do not pour or spray any liquid onto this product or its components. Accidental spillage of liquid into this product may cause serious damage. If this occurs, immediately turn off this product and unplug the power plug from the power outlet. Contact an authorized service representative for service.
- Unplug this product when unused for a long period of time. Take out all the batteries from any components of this product to avoid leaking. Do not use leaked batteries.
- Unplug the power cord before moving this product.
- Always lock the casters when using a mobile stand. Do not unlock the casters unless moving this product.
- If this product falls down, immediately turn off the product and unplug the power cord. Otherwise, it may cause fire or electric shock.
- Keep the writing surface clean. Do not use an overly dirty eraser.
- Turn off the product before cleaning.
- Use commercially available whiteboard cleaner for hard-to-erase stains.
- Use only the designated markers and erasers. Use of accessories other than those authorized (such as oil-based markers) may damage the screen or result in hard-to-erase markings.
- For the use of wireless USB receiver, connect only to a computer that is compliant with the indicated USB interface.

Product Information

Packaging Checklist

Multi-Touch IWB		
Item	Description	Quantity
1	Multi-Touch Interactive Whiteboard	1
2	USB Cable (6 meters)	1
3	Pen Tray	1
4	Plastic Stylus	2
5	Wall Mount Kit	1
6	Installation CD-ROM	1
7	Eraser	1
8	Hotkey strip	1

Optional Accessories		
 <p>USB Wireless Receiver</p>	 <p>Sound Bar System</p>	 <p>Mobile Stand</p>
 <p>Document Camera</p>	 <p>Projector Mount</p>	 <p>Electrical Mobile Stand + Projector Mount</p>
 <p>Voting System (including ARS Receiver)</p>		
		Active Pen Tray

Note: Please contact your local distributor for more details.

Wall Mount Installation

Type 1

Note: For wall installation of Multi-Touch Boards with Multi Touch Speakers use 40mm wall mount supplied with Multi-Touch speakers.

- Step 1** Attach suspender (6) by screwing to board, see figure 1.
- Step 2** Measure the position of top hangers for hanging (3), see figure 1.
- Step 3** Install wall plugs (1) and hangers 40mm (3), see figure 1.

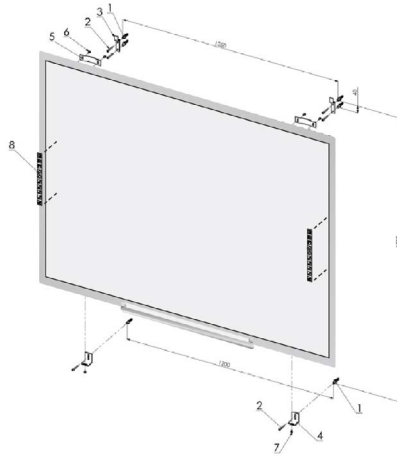

- Step 4** Use double side tape to attach the speaker's HUB in center of the pentray.

- Step 5** Attach speakers to the frame from back of the board, see figure 2.

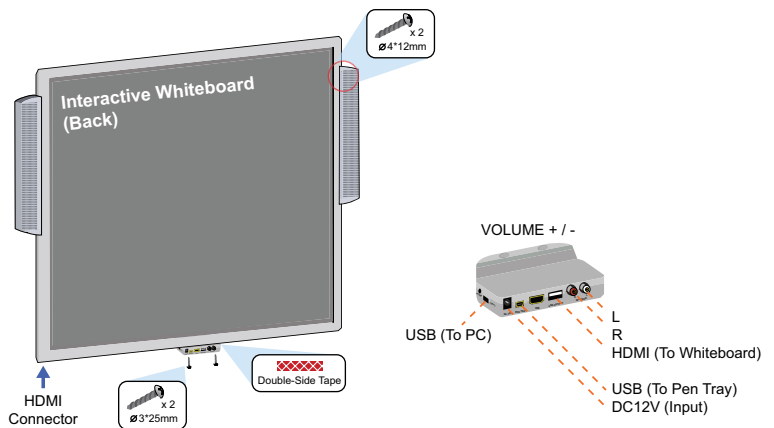

Wall Mount Installation

Type 1

- Step 6** Lead / hide cables behind the board using tape.
- Step 7** Install pentray with HUB on the board.
- Step 8** Connect HDMI - HDMI and L and R Audio cables, see figure 3.

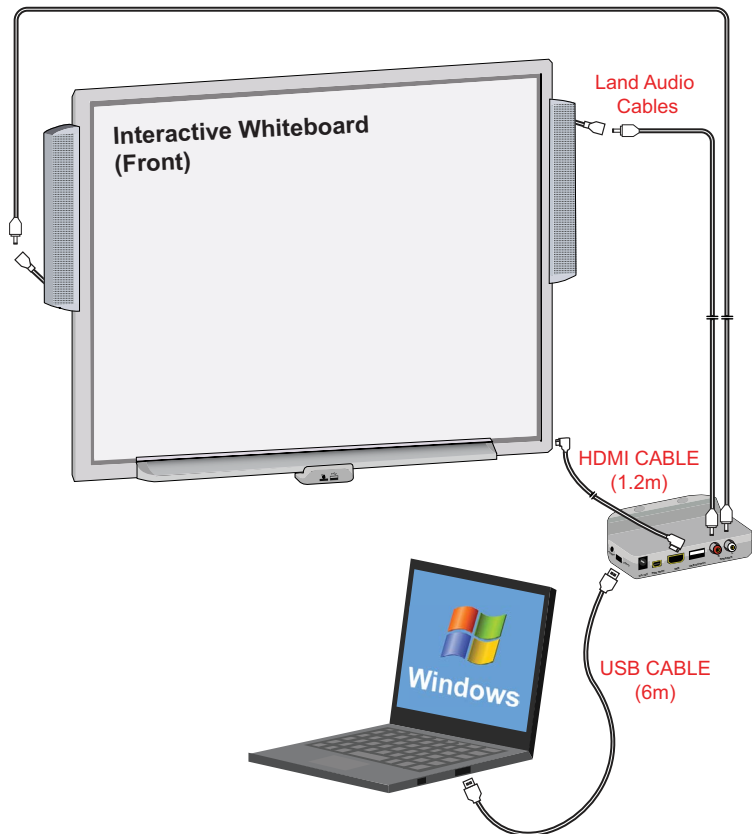

- Step 9** Measure and install wall plugs (1), screws (2) and square (4), see figure 1.
- Step 10** Hang board on the wall.
- Step 11** Connect board to the PC with micro USB - USB cable, see figure 3.

Wall Mount Installation

Type 2

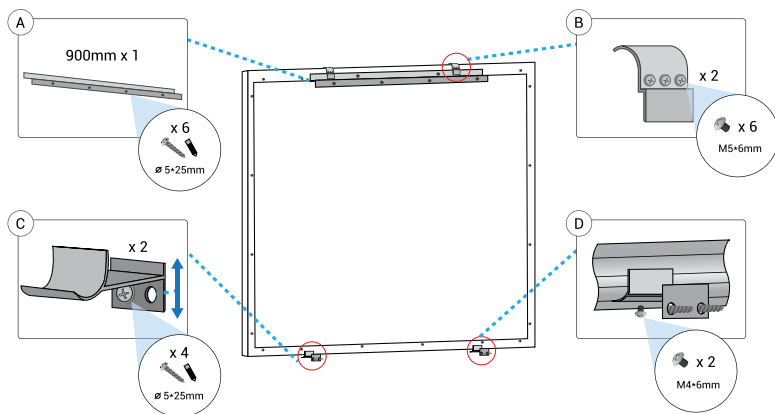

Step 1 Determine the desired wall mount location.

Step 2 Ensure the wall mount Part A is level.
Mark the mounting holes on the wall.

Step 3 Screw the wall mount into the wall surface.
Make sure it is securely mounted and stays level.

Step 4 Install the Parts B on the board.

Step 5 Hang the board on Part A.

Step 6 Install the Parts C&D. Mark the screw hole first, then, install the Parts directly. Make sure the Parts C&D holding the board firmly.

 **WARNING**

- Follow all installation instructions carefully.
- At least two qualified service technicians are required to install this product. Ensure to handle with care during the installation, avoiding serious injury and/or product damage.
- BEFORE the installation, please make sure both wall material and wall strength are suitable. Otherwise, the board might fall which may cause injury and/or product damage. Please consult your dealer for details.
- Use only the designated wall mount and mounting screws.
- Make sure the wall mount is firmly and securely anchored to a solid structure.
- Make sure the board is fastened firmly and securely to the wall mount before using it.

 **CAUTION**

- Do not install this product in location where it may be exposed directly to sunlight, near heating equipment, or near air-conditioning vents.
- Do not install this product in strong sunlight or strong lighting location.
- Do not install this product in location where the temperature may change suddenly.

Multi-touch Board Connection Setup

Windows OS Setup



- Connect the Multi-Touch Board to a PC / laptop using the USB cable provided.
- Connect the PC / laptop to a projector using a VGA cable.

Wireless Model Connection Diagram



- Connect the Power Adaptor to the Multi-Touch Board using the USB cable provided. Plug the Power Adaptor to a power outlet.
- Connect the Wireless Receiver to a PC / laptop.
- Connect the PC / laptop to a projector using a VGA cable.

Multi-touch Board Software Installation

Windows OS Setup

1. To run the Installation Program, double-click the file “Multi-touch board Setup”.

2. Click “Next” to continue.



3. Choose destination location and click “Next” to continue.

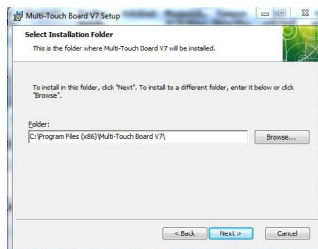

4. Click “Finish” to complete the software installation.



Calibration Driver

Calibration

Steps

1. Click the Multi-Touch IWB driver icon ().
2. Select "Calibration" on Configuration Main Menu.
3. Press the center of the red target using a finger/stylus pen.
4. Press the next red target.
5. Calibration is completed when all red targets have been detected.



Save User Profile

Step 1



1. After calibration is completed, click "Yes" to save the calibration setting.

Step 2

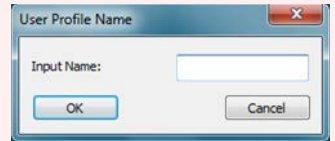

2. Input a user profile name.
3. Click "OK".

Remark:

Make sure to calibrate the Multi-Touch IWB for the first time installation.

Settings

Device Information

User can check the device information in "Settings" menu.

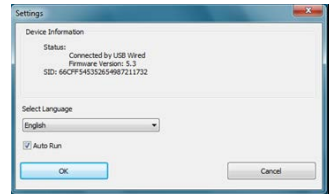

Select Language

1. Select the language from the drop-down menu.
2. Click "OK".

Auto Run

1. Click on the "Checkbox" to enable/disable auto run.
2. Click "OK".

MS Office Ink Tools

Microsoft Office Ink tools will appear when Multi-touch IWB is connected.
(Only for Vista & Windows-7, 8)

Please follow these steps to use ink tools to draw in MS Office.
(Office 07 is shown below as an example).

1. Open Microsoft Office e.g. Excel, click on Review to find the icon of “Start Inking”. (No icon will be shown if whiteboard is disconnected)

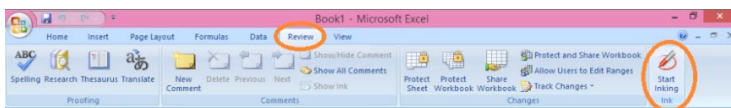

2. You can select different pen tools, colors and pen width.



3. Under Microsoft office Annotations tools, users can use the annotations directly on the top of PowerPoint, Word and Excel. Just Plug-n Play.

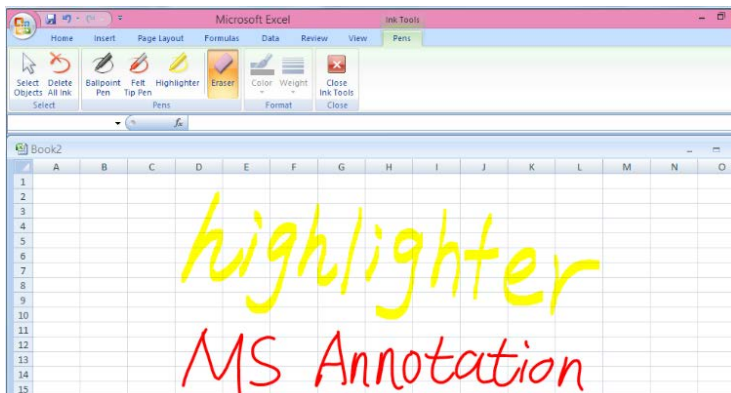

Basic Controls

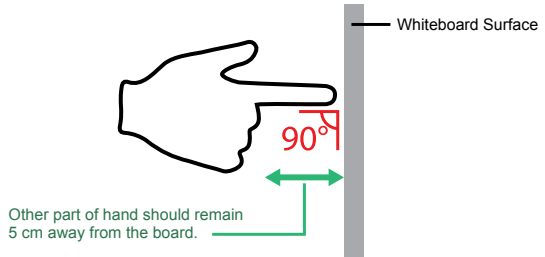

While using finger to operate the whiteboard, please be caution on the following points:



1. The finger should be about 90° to the whiteboard surface.
2. Avoid other fingers and thumb touching the whiteboard. Make sure it has about 4-5 cm apart from the surface.
3. Avoid the clothing and hair touching the surface.

Gesture	The way to perform	
Click & Select Object	Tap on the whiteboard	
Right Click	Tap and hold Hold for 2 seconds	
Move Object with Selection	Drag with 1 finger after selecting it	
Selection	Drag a desire area with 2 fingers on 1 point	
Erase	Flatten the hand and move	
Zoom In	1 Finger on each hand moving away each other	

Basic Controls

Gesture	The way to perform	
Zoom Out	1 Finger on each hand moving toward each other	
Rotate Object	1 Finger on each hand Rotating clockwise/ anti-clockwise	
Scrolling	Multi-fingers Moving to a desire direction	







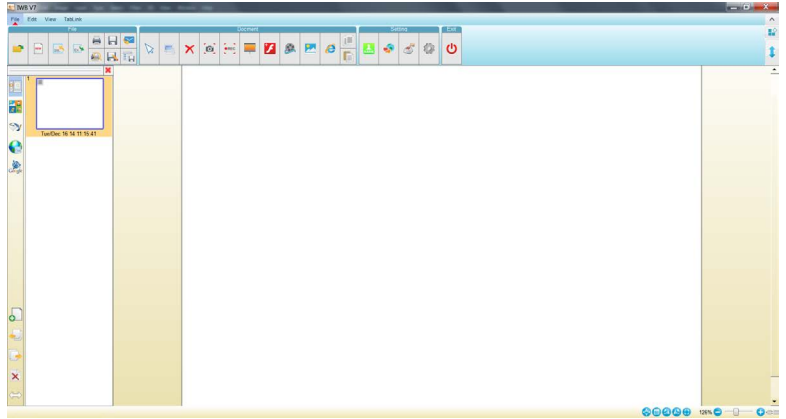















Functions in the Software

There are different functions in the V7.



































By clicking on the different tab, you could switch to different functions and toolbar.











Functions in File

Icon	Functions	Icon	Functions
	Open		New document
	Import document		Export document
	Print		Print preview
	Save		Save as
	Send email		Save as template
	Pointer		Background transparent
	Delete selected object		Screen capture
	Screen record		Curtain
	Insert Flash		Insert Video
	Insert image		Insert Web browser
	Copy		Paste
	Select toolbar setting profile		Setup language
	Setup hotkey		Option
	Exit		

Functions in Edit

Icon	Functions	Icon	Functions
	Pointer		Select Color
	Marker		Magic Pen
	Highlighter		Crayon
	Handwriting marker		4 Color Pen
	2 Color pen		Middle Eraser
	Cut		Object Eraser
	Delete Selected object		Undo
	Redo		Soft Keyboard
	Insert Text		Insert Table
	Insert Cuboids		Insert Cylinder
	Insert Sphere		Insert Cone
	Insert Prism		Insert Rectangle
	Insert Semi Ellipse		Insert Circle
	Insert Obtuse Triangle		Insert Octagon
	Insert Acute Triangle		Insert Parallelogram
	Insert Trapezoid		Insert Diamond
	Math Formula		Math Graph Tool

Functions in Edit

Icon	Functions	Icon	Functions
	Insert Sound		Insert 3D Model
	Ruler		Protractor
	Set Square		Compass
	Document Camera		Voting

Functions of Navigation Bar



Inserting Material into the Software

Besides drawing, you can insert different materials into the software, enriching your documents full of attractive contents.



Insert Image



Insert Flash



Insert Audio



Insert Movie



Insert 3D Model



Hyperlink

You can add hyperlink to any object. You can link to a webpage, a page in the document or a local file.

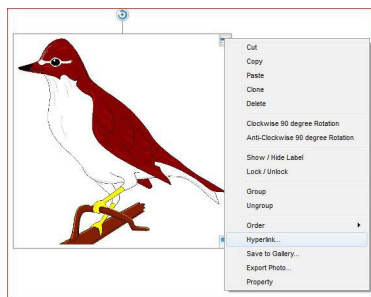

1. URL

Link directly to a specific webpage

2. Page

Link to a specific page inside the IWB document

3. File

Link to a specific local file

4. By Icon

Hyperlink launch by Hyperlink Icon

5. By Object

Hyperlink launch by selected object

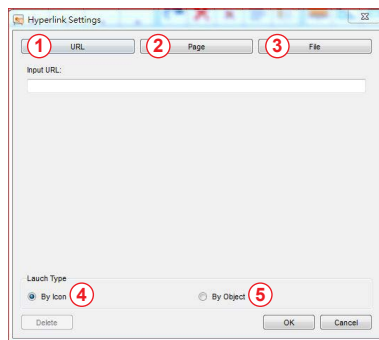



Library

You can access the library in the navigation bar. There are 2 kinds of library in the software.

In public library, It contains 2D images, 3D model and interactive contents. Interactive contents allow users to edit and save for teaching and presentation purpose.

In personal library, you can add any contents.. Just click on the menu list of the object and select “Save to gallery” to save your file.



Menu List

Left click the Menu List to find the hidden functions.

Lock/ Unlock – Lock object so it will not be moved with user’s action.

Order – When there are two objects overlapping, you can adjust the order to show the effect of different layers. e.g. Bring to forward , send to backward, bring to front, send to bottom.

Group / ungroup – By grouping some objects, those objects will become recognition as one object. Moving and resizing the group will take effect to the whole group of objects.

Show / Hide label – Label can be shown on objects for indication.

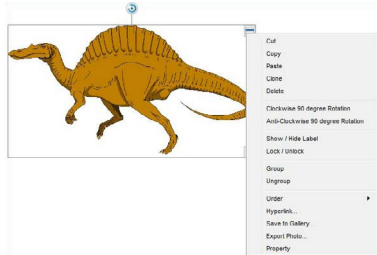

Page Viewing



There are different kinds of viewing styles. You can choose the one that fulfill your need.

- A:** Full Screen
- B:** New Page Property
- C:** Rotate 90 degree clockwise
- D:** Rotate 90 degree anti-clockwise
- E:** Zoom resume back to normal
- F:** Adjusting the Zoom
- G:** Hardware connecting status

Zooming

The bottom tray bar provides quick access of the zooming function. Adjust the zoom with / and resume to a normal view by the zoom reset ().

Full Screen Mode

Toggle on the full screen mode for a larger drawing area. You can also switch quickly between other programs and the software.



Icon	Description	Icon	Description
	Perform Windows action		Toggle transparent Background
	Pointer		Move Through page
	Marker		Smart Pen
	Highlighter		Magic Pen
	Select Color		Eraser
	Undo		Redo
	Previous page		Next page
	Screen capture		Voting
	Clear Page		Exit



Document Camera

You can use the document camera tool with the document camera (optional) or other camera devices which connected to your PC. Select the proper device from the list of camera (| **FaceTime HD Camera**) available in your computer. You can perform similar actions in the document camera tool like the IWB software. For example, drawing, zooming and screen capture.

Here are the functions in Document camera:

Icon	Function	Icon	Function
	Move Page		Zoom in
	Marker		Zoom out
	Smart-pen		Area zoom in
	Clear all		Page Rotate
	Select colors		Capture Screen
	Return to normal view		Setting



Video Player

With the help of Video Player, you can watch most of the videos on the computer. Click  to insert an existing video on the computer, and then start playing it. You can also draw on the screen and resize the video immediately.

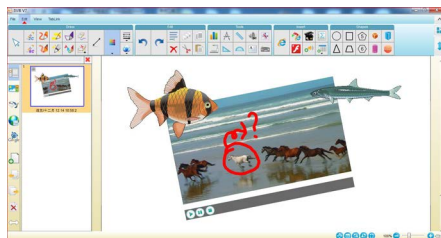

Text Speaker

The Text speaker can pronounce the word that you entered in the document. It supports multi – language. Click on the text after selecting the tool, it will automatically pronounce the text.

The language it speaks depends on the windows setting. You can set it in Control Panel → Speech Recognition → Text to Speech. You can choose different voice and adjust the voice speed.







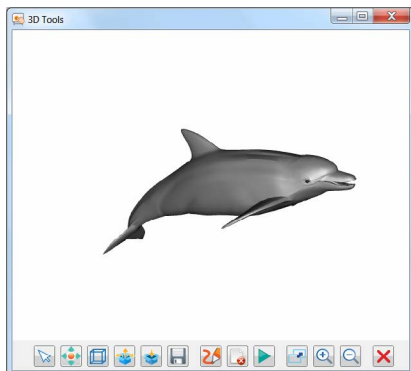





 **3D Tool**

The 3D tool supports viewing of the 3D Model contents. The tool can move, rotate, and zoom in/out to view the 3D object. You can screen capture the model and it will insert into the IWB document automatically.

Besides, user can download 3D images from Google to enlarge your 3D library. Just click  , you will be linked to: sketchup.google.com/3dwarehouse/



Just download the zip file and drag it to the software and save it to the 3D Library. Here is the function detail of 3D tools:

Icon	Function	Icon	Function
	Pointer		Rotate
	View Line Model		Show all Component
	Hide Component		Save
	Pen		Clear Drawings
	Rotation		Full Screen
	Zoom In		Zoom Out
	Exit		

 **Ruler,**  **Protractor,**  **Compass,**  **Set Square**

These are the common tools in the software. They are in actual scale. In V7, you can now draw with the help of the Ruler and Protractor. Just draw on the edge of ruler or protractor, the drawing line will follow the edge of them.

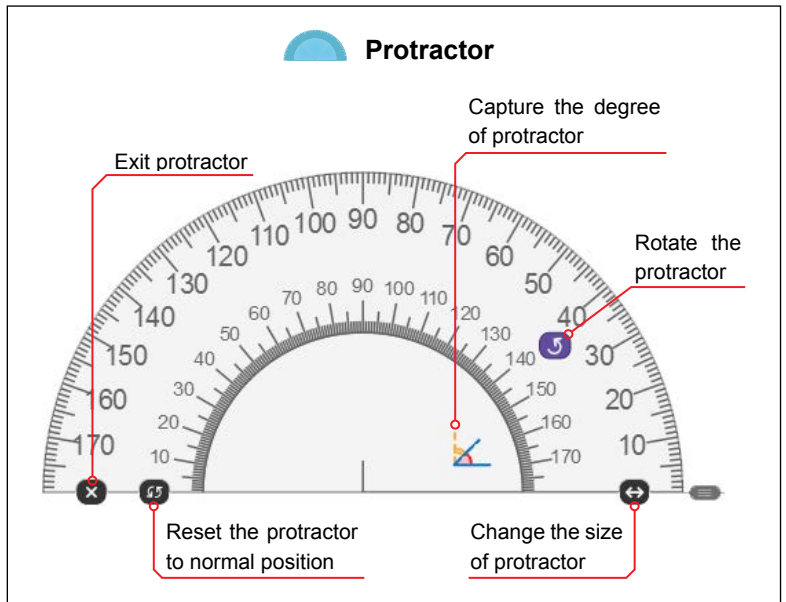
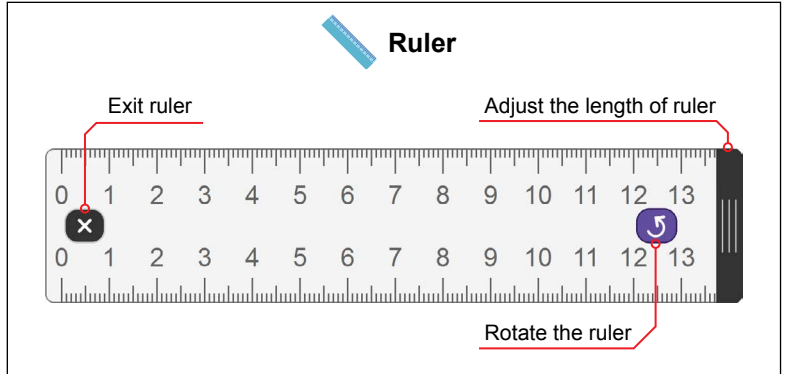

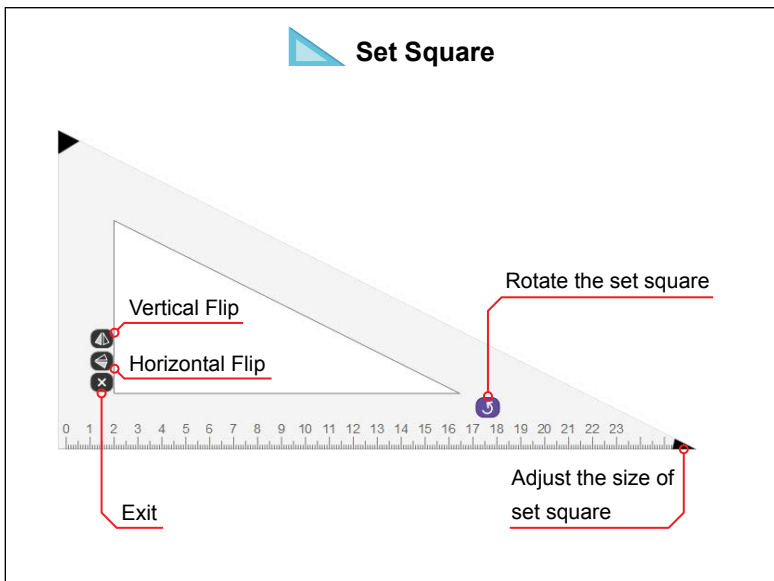
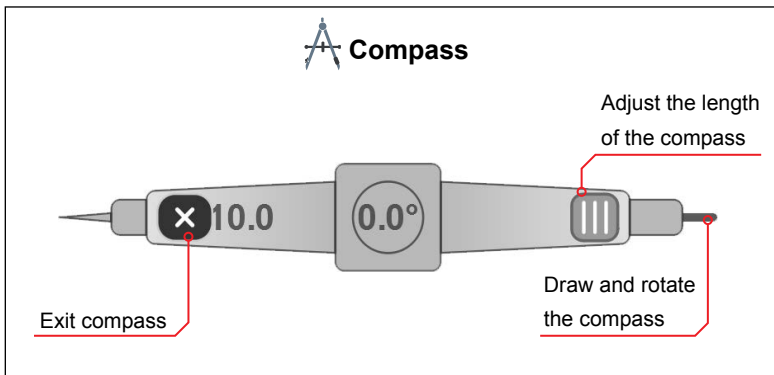





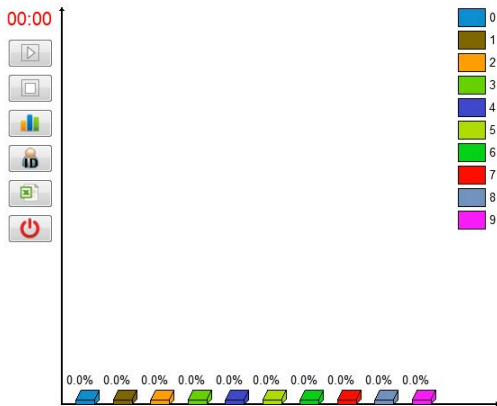

Voting

You can call up a simple vote within the software. A voting system (optional accessory) is required for the voting function. Please contact your local distributor for more details.



Icon	Function	Description
00:00	Timer	Count-up / Countdown Time
	Begin	Start voting
	Stop	Stop voting
	Bar Chart	show voting result by bar chart
	Student ID	Turn on/ off Student ID
	Export Report	Export Report
	Exit	Exit Voting

Managing the files



Save as template

You can save a page as a template, so that you can load the file immediately at “My Template” in the Library.



Import

Import Third party format document into the document.

Here is the list of supporting format:

.pdf	.notebook	.iwb
.ppt	.pptx	.doc
.docx	.xls	.xlsx



Export

Export document into third party format. Here is the list of supporting format:

.pdf	.iwb	.pptx
.html	.svg	.jpeg
.jpg	.bmp	.png
.avi	.mpeg	.swf



Language setup

Change language and hand writing recognition language here.



Managing the files



Select user profile

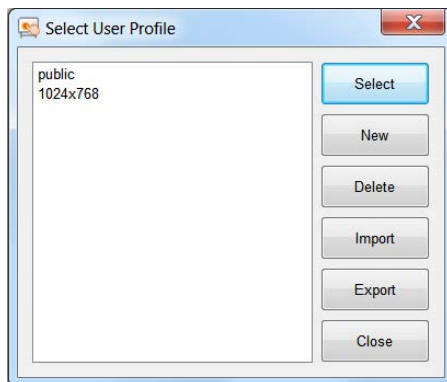

Save the toolbar setting into different user profile. You can also Import / export the profile from / to other computer.



Hotkey Calibration



Before calibration of hotkey, enable the hotkey in Settings.

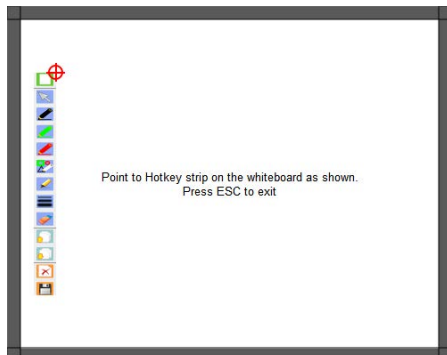

Follow the steps on the screen to complete the calibration.

Notices

Every effort has been made to ensure all information contained in this user guide is correct, but the accuracy or completeness is not guaranteed. Before using this product, you must evaluate it and determine if it is suitable for your intended application. You assume all risks and liability associated with such use. Any statements related to this product which is not contained in this manual or any contrary statements contained on your purchase order shall have no force of effect unless expressly agreed upon, in writing, by this company.

Without this company permission, reproduction or reprinting this user guide or any part is prohibited.

The contents of this user guide are subject to change without prior notice.

Date of modification: 20-Jan-2015